

## TWO POINTS/THREE POINTS INTERNAL MICROMETERS

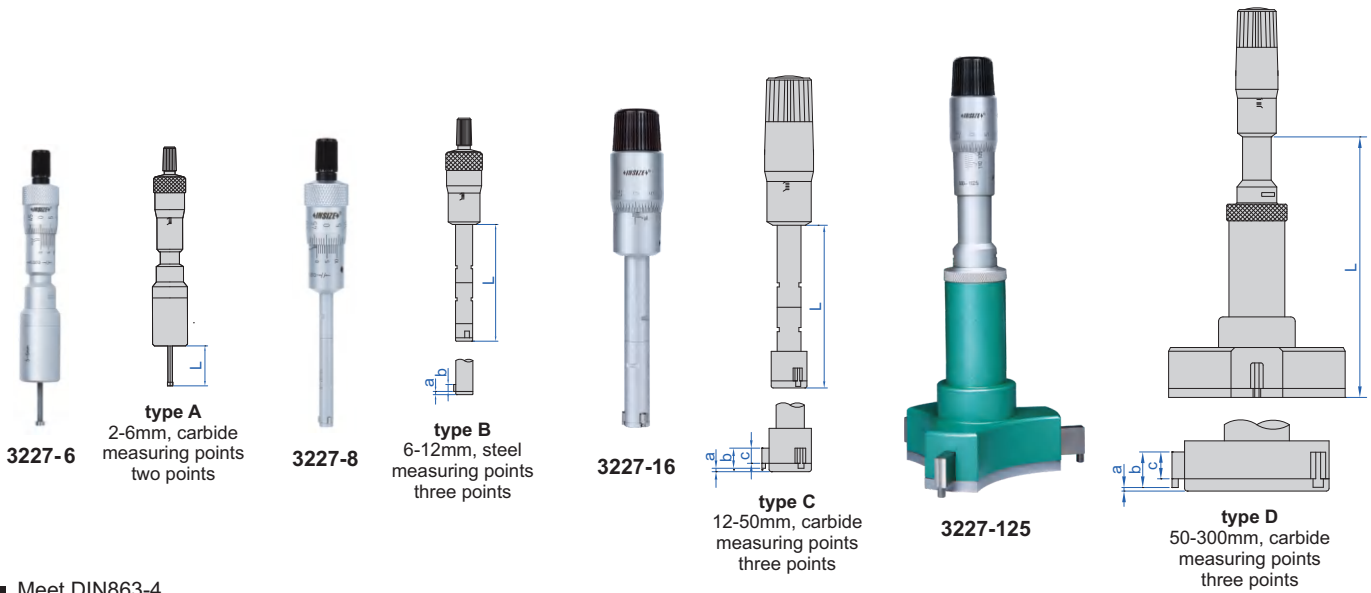

- Meet DIN863-4
- 2-12mm: graduation 0.001mm  
12-300mm: graduation 0.005mm
- Ratchet stop
- Optional accessory: setting rings (code **6312**), micrometer stand and clamp (code **6301** and **6301-2**)

### Individual

(mm)

Code	Range	Type	Accuracy	Setting ring	Extension rod (included)	L	a	b	c
3227-2 *	2-2.5mm	A (two points)	6µm	Ø2.5 (included)	—	12	—	—	—
3227-3 *	2.5-3mm	A (two points)	6µm	Ø2.5 (included)	—	12	—	—	—
3227-4 *	3-4mm	A (two points)	6µm	Ø4 (included)	—	22	—	—	—
3227-5 *	4-5mm	A (two points)	6µm	Ø5 (included)	—	22	—	—	—
3227-6 *	5-6mm	A (two points)	6µm	Ø6 (included)	—	22	—	—	—
3227-8 *	6-8mm	B (three points)	4µm	Ø6 (included)	100	54.5	1.5	2.5	—
3227-10 *	8-10mm	B (three points)	4µm	Ø8 (included)	100	54.5	1.5	2.5	—
3227-12 *	10-12mm	B (three points)	4µm	Ø10 (included)	100	54.5	1.5	2.5	—
3227-16 *	12-16mm	C (three points)	4µm	Ø16 (included)	150	80	0.5	6	4.5
3227-20 *	16-20mm	C (three points)	4µm	Ø16 (included)	150	80	0.5	6	4.5
3227-25 *	20-25mm	C (three points)	4µm	Ø25 (included)	150	90	0.5	8	6
3227-30 *	25-30mm	C (three points)	4µm	Ø25 (included)	150	90	0.5	8	6
3227-40 *	30-40mm	C (three points)	4µm	Ø40 (included)	150	97	0.5	14	12
3227-50 *	40-50mm	C (three points)	5µm	Ø40 (included)	150	97	0.5	14	12
3227-63 *	50-63mm	D (three points)	5µm	Ø62 (included)	150	114	0.5	17.5	14.5
3227-75 *	62-75mm	D (three points)	5µm	Ø62 (included)	150	114	0.5	17.5	14.5
3227-88 *	75-88mm	D (three points)	5µm	Ø87 (included)	150	114	0.5	17.5	14.5
3227-100 *	87-100mm	D (three points)	5µm	Ø87 (included)	150	114	0.5	17.5	14.5
3227-125 *	100-125mm	D (three points)	6µm	optional	150	140	0.9	29	25
3227-150 *	125-150mm	D (three points)	6µm	optional	150	140	0.9	29	25
3227-175 *	150-175mm	D (three points)	7µm	optional	150	140	0.9	29	25
3227-200 *	175-200mm	D (three points)	7µm	optional	150	140	0.9	29	25
3227-225	200-225mm	D (three points)	8µm	optional	150	140	0.9	29	25
3227-250	225-250mm	D (three points)	8µm	optional	150	140	0.9	29	25
3227-275	250-275mm	D (three points)	9µm	optional	150	140	0.9	29	25
3227-300	275-300mm	D (three points)	9µm	optional	150	140	0.9	29	25

To be continued

Continued from previous page



micrometer stand with clamp (optional)



setting ring

2-100mm: included  
100-300mm: optional

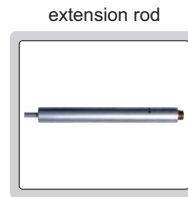

extension rod

included



3227-504

Set

Code	Range	Micrometers included	Setting ring (included)	Extension rod (included)
3227-232 *	2-3mm	2-2.5mm, 2.5-3mm	Ø2.5mm	—
3227-363 *	3-6mm	3-4mm, 4-5mm, 5-6mm	Ø4mm, Ø5mm, Ø6mm	—
3227-123 *	6-12mm	6-8mm, 8-10mm, 10-12mm	Ø6mm, Ø8mm, Ø10mm	100mm
3227-202 *	12-20mm	12-16mm, 16-20mm	Ø16mm	150mm
3227-504 *	20-50mm	20-25mm, 25-30mm, 30-40mm, 40-50mm	Ø25mm, Ø40mm	150mm
3227-1004 *	50-100mm	50-63mm, 62-75mm, 75-88mm, 87-100mm	Ø62mm, Ø87mm	150mm

\* Supplied with manufacturer inspection certificate

IP65  
WATERPROOF

DATA  
OUTPUT

## DIGITAL TWO POINTS/THREE POINTS INTERNAL MICROMETERS

INSPECTION  
CERTIFICATE



3127-5

**type A**  
2-6mm, carbide  
measuring points  
two points



3127-12

**type B**  
6-12mm, steel  
measuring points  
three points



3127-40

**type C**  
12-50mm, carbide  
measuring points  
three points



3127-125

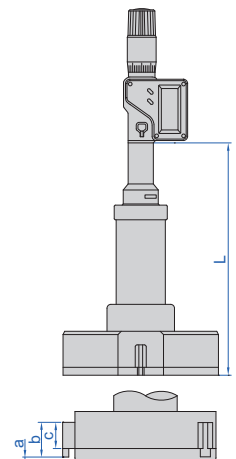

**type D**  
50-300mm, carbide  
measuring points  
three points

- Resolution 0.001mm/0.00005" (resolution of 3127-275 and 3127-300 is 0.001mm/0.0001")
- IP65 dust/waterproof
- Buttons: on/off, set, mm/inch, data transmit
- Data output
- Automatic power off
- Ratchet stop
- Optional accessory: wireless transmitter code 7315-31 (receiver is needed) page 6, bluetooth transmitter code 7214-31 page 12, data output cable code 7302-31 page 20, setting ring (code 6312), micrometer stand and clamp (code 6301 and 6301-2)

To be continued

Continued from previous page

micrometer stand with clamp (optional)



setting ring



2-100mm: included  
100-300mm: optional

extension rod

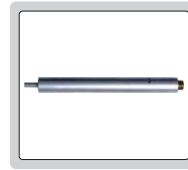

included



3127-202

7

Individual

(mm)

Code	Range	Type	Accuracy	Setting ring	Extension rod (included)	L	a	b	c
3127-2*	2-2.5mm/0.08-0.10"	A (two points)	6µm	Ø2.5 (included)	—	12	—	—	—
3127-3*	2.5-3mm/0.10-0.12"	A (two points)	6µm	Ø2.5 (included)	—	12	—	—	—
3127-4*	3-4mm/0.12-0.16"	A (two points)	6µm	Ø4 (included)	—	22	—	—	—
3127-5*	4-5mm/0.16-0.20"	A (two points)	6µm	Ø5 (included)	—	22	—	—	—
3127-6*	5-6mm/0.20-0.24"	A (two points)	6µm	Ø6 (included)	—	22	—	—	—
3127-8*	6-8mm/0.24-0.31"	B (three points)	4µm	Ø6 (included)	100	57	1.5	2.5	—
3127-10*	8-10mm/0.31-0.39"	B (three points)	4µm	Ø8 (included)	100	57	1.5	2.5	—
3127-12*	10-12mm/0.39-0.47"	B (three points)	4µm	Ø10 (included)	100	57	1.5	2.5	—
3127-16*	12-16mm/0.47-0.63"	C (three points)	4µm	Ø16 (included)	150	99	0.5	6	4.5
3127-20*	16-20mm/0.63-0.79"	C (three points)	4µm	Ø16 (included)	150	99	0.5	6	4.5
3127-25*	20-25mm/0.79-0.98"	C (three points)	4µm	Ø25 (included)	150	105	0.5	8	6
3127-30*	25-30mm/0.98-1.18"	C (three points)	4µm	Ø25 (included)	150	105	0.5	8	6
3127-40*	30-40mm/1.18-1.57"	C (three points)	4µm	Ø40 (included)	150	110	0.5	14	12
3127-50*	40-50mm/1.57-1.97"	C (three points)	5µm	Ø40 (included)	150	110	0.5	14	12
3127-63*	50-63mm/1.97-2.48"	D (three points)	5µm	Ø62 (included)	150	127	0.5	17.5	14.5
3127-75*	62-75mm/2.44-2.95"	D (three points)	5µm	Ø62 (included)	150	127	0.5	17.5	14.5
3127-88*	75-88mm/2.95-3.46"	D (three points)	5µm	Ø87 (included)	150	127	0.5	17.5	14.5
3127-100*	87-100mm/3.43-3.94"	D (three points)	5µm	Ø87 (included)	150	127	0.5	17.5	14.5
3127-125*	100-125mm/3.94-4.92"	D (three points)	6µm	optional	150	175	0.9	29	25
3127-150*	125-150mm/4.92-5.91"	D (three points)	6µm	optional	150	175	0.9	29	25
3127-175*	150-175mm/5.91-6.89"	D (three points)	7µm	optional	150	175	0.9	29	25
3127-200*	175-200mm/6.89-7.87"	D (three points)	7µm	optional	150	175	0.9	29	25
3127-225	200-225mm/7.87-8.86"	D (three points)	8µm	optional	150	175	0.9	29	25
3127-250	225-250mm/8.86-9.84"	D (three points)	8µm	optional	150	175	0.9	29	25
3127-275	250-275mm/9.84-10.83"	D (three points)	9µm	optional	150	175	0.9	29	25
3127-300	275-300mm/10.83-11.81"	D (three points)	9µm	optional	150	175	0.9	29	25

Set

Code	Range	Micrometers included	Setting ring (included)	Extension rod (included)
3127-232*	2-3mm/0.08-0.12"	2-2.5mm, 2.5-3mm	Ø2.5mm	—
3127-363*	3-6mm/0.12-0.24"	3-4mm, 4-5mm, 5-6mm	Ø4mm, Ø5mm, Ø6mm	—
3127-123*	6-12mm/0.24-0.47"	6-8mm, 8-10mm, 10-12mm	Ø6mm, Ø8mm, Ø10mm	100mm
3127-202*	12-20mm/0.47-0.79"	12-16mm, 16-20mm	Ø16mm	150mm
3127-504*	20-50mm/0.79-1.97"	20-25mm, 25-30mm, 30-40mm, 40-50mm	Ø25mm, Ø40mm	150mm
3127-1004*	50-100mm/1.97-3.94"	50-63mm, 62-75mm, 75-88mm, 87-100mm	Ø62mm, Ø87mm	150mm

\*Supplied with manufacturer inspection certificate



## WIDE RANGE THREE POINTS INTERNAL MICROMETERS

- Meet DIN863-4
- Graduation 0.001mm
- Carbide measuring faces
- Ratchet stop
- Setting rings are included (except 200-300mm)

Code	Range	Accuracy	Setting ring
<b>3228-70*</b>	50-70mm	5µm	Ø50mm (included)
<b>3228-100*</b>	70-100mm	5µm	Ø70mm (included)
<b>3228-150*</b>	100-150mm	6µm	Ø100mm (included)
<b>3228-250*</b>	150-250mm	8µm	Ø150mm (included)
<b>3228-300*</b>	200-300mm	9µm	Ø200mm (optional)

\*Supplied with manufacturer inspection certificate

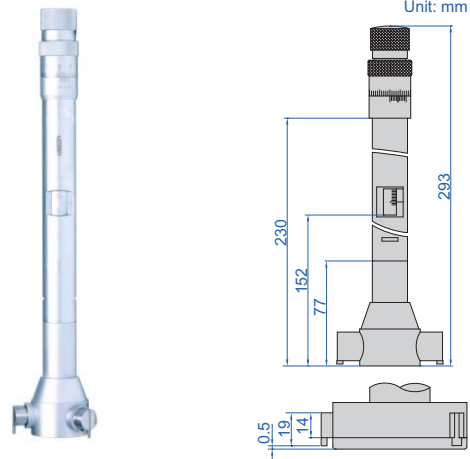

3228-70

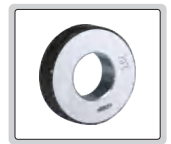

setting ring



## DIGITAL WIDE RANGE THREE POINTS INTERNAL MICROMETERS



- Meet DIN863-4
- Resolution 0.001mm/0.00005" (resolution of **3128-300** is 0.001mm/0.0001")
- IP54 dust/waterproof
- Buttons: on/off, set, mm/inch
- Data output
- Automatic power off
- Carbide measuring faces
- Ratchet stop
- Supplied with extension rods
- Setting rings are included (except 200-300mm)
- Optional accessory: wireless transmitter code **7315-30** (receiver is needed) page 5, bluetooth transmitter code **7214-30** page 11, data output cable code **7302-30** page 20



3128-150

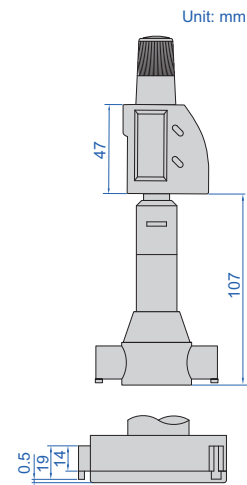

Code	Range	Accuracy	Setting ring	Extension rod (included)
<b>3128-70*</b>	50-70mm/1.97-2.76"	5µm	Ø50mm (included)	150mm
<b>3128-100*</b>	70-100mm/2.76-3.94"	5µm	Ø70mm (included)	150mm
<b>3128-150*</b>	100-150mm/3.94-5.91"	6µm	Ø100mm (included)	150mm
<b>3128-250*</b>	150-250mm/5.91-9.84"	8µm	Ø150mm (included)	150mm
<b>3128-300*</b>	200-300mm/7.87-11.81"	9µm	Ø200mm (optional)	150mm

\*Supplied with manufacturer inspection certificate



setting ring



extension rod (included)

# DIGITAL WIDE RANGE THREE POINTS INTERNAL MICROMETER

**IP54**  
WATERPROOF

DATA  
OUTPUT

extension rod (included)



50mm replaceable measuring jaws (included)



100mm replaceable measuring jaws (included)



3621-500

Unit: mm

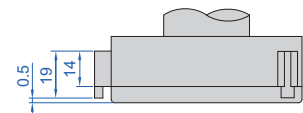
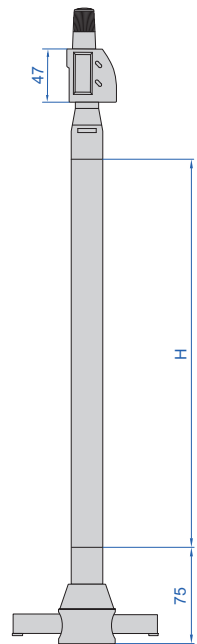

- Resolution 0.001mm/0.0001" (resolution is 0.00005" when <10")
- Replaceable measuring jaws, wide measuring range
- Buttons: on/off, set, mm/inch
- Data output
- Automatic power off
- Carbide measuring faces
- Ratchet stop
- Supplied with extension rods
- Optional accessory:
  - setting rings (code **6312-200**, **6312-300**, **6312-400**),
  - wireless transmitter code **7315-30** (receiver is needed) page 5,
  - bluetooth transmitter code **7214-30** page 11,
  - data output cable code **7302-30** page 20

Code	Range	Accuracy	Measuring jaws (included)	Extension rods H (included)
3621-500	200-500mm/7.87-19.69"	(1+L/50) $\mu\text{m}$ *	50mm (3pcs), 100mm (3pcs)	150mm, 500mm

\*L=maximum measuring diameter (mm)



## PISTOL GRIP THREE POINTS BORE GAUGES

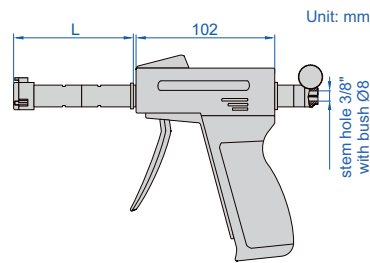

- Optional accessory: digital indicators (code **2103-101F**, resolution 0.001mm/0.00005"), setting rings (code **6312**)

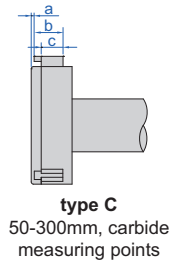
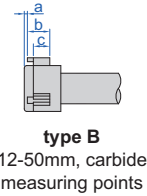
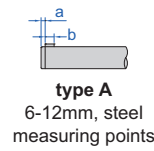
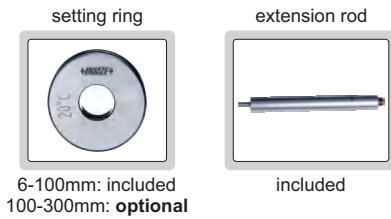

### Individual

(mm)

Code	Range	Type	Accuracy (without digital indicator)	Setting ring	Extension rod (included)	L	a	b	c
<b>2124-8 *</b>	6-8mm	A	4µm	Ø6mm (included)	100mm	50	1.5	2.5	—
<b>2124-10 *</b>	8-10mm	A	4µm	Ø8mm (included)	100mm	50	1.5	2.5	—
<b>2124-12 *</b>	10-12mm	A	4µm	Ø10mm (included)	100mm	50	1.5	2.5	—
<b>2124-16 *</b>	12-16mm	B	4µm	Ø16mm (included)	150mm	65	0.5	6	4.5
<b>2124-20 *</b>	16-20mm	B	4µm	Ø16mm (included)	150mm	65	0.5	6	4.5
<b>2124-25 *</b>	20-25mm	B	4µm	Ø25mm (included)	150mm	91	0.5	8	6
<b>2124-30 *</b>	25-30mm	B	4µm	Ø25mm (included)	150mm	91	0.5	8	6
<b>2124-40 *</b>	30-40mm	B	4µm	Ø40mm (included)	150mm	97	0.5	14	12
<b>2124-50 *</b>	40-50mm	B	5µm	Ø40mm (included)	150mm	97	0.5	14	12
<b>2124-63 *</b>	50-63mm	C	5µm	Ø62mm (included)	150mm	112	0.5	17.5	14.5
<b>2124-75 *</b>	62-75mm	C	5µm	Ø62mm (included)	150mm	112	0.5	17.5	14.5
<b>2124-88 *</b>	75-88mm	C	5µm	Ø87mm (included)	150mm	112	0.5	17.5	14.5
<b>2124-100 *</b>	87-100mm	C	5µm	Ø87mm (included)	150mm	112	0.5	17.5	14.5
<b>2124-125 *</b>	100-125mm	C	6µm	optional	150mm	140	0.9	29	25
<b>2124-150 *</b>	125-150mm	C	6µm	optional	150mm	140	0.9	29	25
<b>2124-175 *</b>	150-175mm	C	7µm	optional	150mm	140	0.9	29	25
<b>2124-200 *</b>	175-200mm	C	7µm	optional	150mm	140	0.9	29	25
<b>2124-225</b>	200-225mm	C	8µm	optional	150mm	140	0.9	29	25
<b>2124-250</b>	225-250mm	C	8µm	optional	150mm	140	0.9	29	25
<b>2124-275</b>	250-275mm	C	9µm	optional	150mm	140	0.9	29	25
<b>2124-300</b>	275-300mm	C	9µm	optional	150mm	140	0.9	29	25

### Set

Code	Range	Probes included	Setting ring (included)	Extension rod (included)
<b>2124-S123 *</b>	6-12mm	6-8mm, 8-10mm, 10-12mm	Ø6mm, Ø8mm, Ø10mm	100mm
<b>2124-S202 *</b>	12-20mm	12-16mm, 16-20mm	Ø16mm	150mm
<b>2124-S504 *</b>	20-50mm	20-25mm, 25-30mm, 30-40mm, 40-50mm	Ø25mm, Ø40mm	150mm
<b>2124-S1004 *</b>	50-100mm	50-63mm, 62-75mm, 75-88mm, 87-100mm	Ø62mm, Ø87mm	150mm



**2124-S504**

\* Supplied with manufacturer inspection certificate